



Assembly Instructions

ELO® Desk/ Table

Before you begin, please make sure all parts and proper quantities are included. (See Part Identifier Key) Any parts damaged during shipment must be reported within 24 hours of receipt. To report information regarding damages or if you have any questions, please call 800.242.2303.

Step 1:

- Place top face down on protected flat surface so threaded inserts are facing up.

Step 2:

- Align leg (see leg options below) with threaded inserts.
- Connect leg to top with the 1/4"-20x15mm Joint Connector Bolts. Use six bolts for each leg.
- Use a screw gun, 4mm Hex Bit and a Drill Bit Extension to tighten the Joint Connector Bolts to the desktop.
- Repeat this step for the rest of the legs.

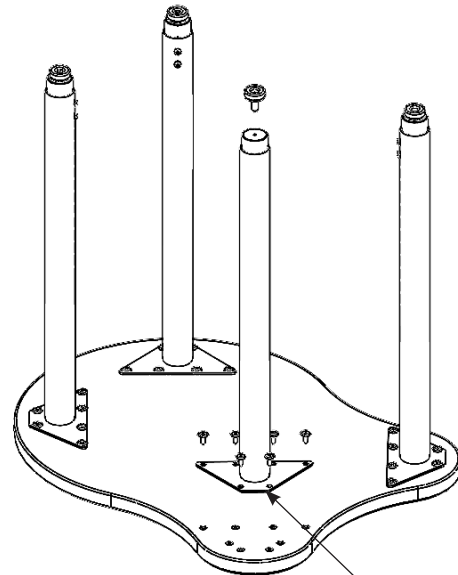

Step: 2

Step 3:

- If your table requires a Support Bar/s, align the bar/s with the pre-drilled pilot holes. Use #8x3/4" Screws to fasten down the Support Bar/s to the top.

Step 4:

- Adjust legs to desired height then flip over.

NOTE: These Assembly Instructions are based on the assembly of the ELO® Adapt-XL Desk with 2" Straight Round Legs. Type and quantity of parts will vary depending on which desk or table is ordered. These instructions comply with all ELO® models.

Tools Required

- Screw Gun
- 4mm Hex Bit
- Phillips Head Screwdriver
- Drill Bit Extension

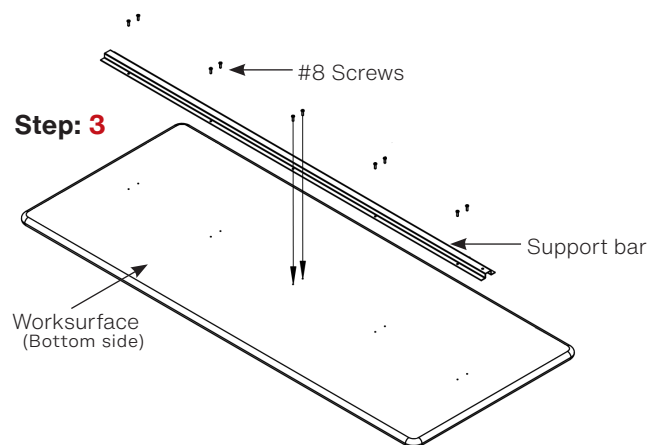

Step: 3

Assembly Instructions

ELO® Desk/ Table

with Dual Wheel Locking Casters
or 2.5" Grand Hank Glides

Step 1:

- Remove Nylon Glide from leg by rotating counterclockwise until glide is free.

Step 2:

- Place stem of optional footing into the hole on the leg. Rotate clockwise until fully inserted into leg.
- Castors are NOT to be used as a leveling device.

Step 3:

- Tighten with a 14mm Open-Ended Wrench (only with the Dual Wheel Casters.)

Step 4:

- Repeat for each caster or glide.

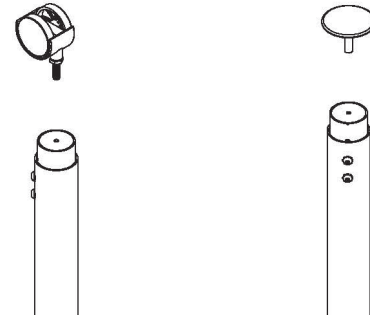

Tools Required

- 14 mm Open Ended Wrench

ELO® Desk/ Table

with Backpack Hook

Step 1:

- Place top face down on protected flat surface.

Step 2:

- Align tab of the Backpack Hook with the metal inserts.

Step 3:

- Use (2) 1/4"-20x15mm Joint Connector Bolts to fasten the tab of the Backpack Hook to the top.

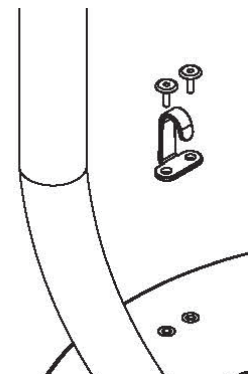





Tools Required

- Screw Gun
- 14 mm Hex Bit

Part Identifier Key







Adjustable Legs

Model #	Smooth Silver SKU	Black SKU	Description	Weight	Overall Height"	
ELO -ADJ	0400570-G4	0400570	ELO® 1.25" Square Adj. Leg	5	26.25 - 31.25	 
ELS -ADJ	04067832-G4	04067832	ELO® 2" Straight Round Adj. Leg	6	26.25 - 41.25	 
ELP -ADJ	04066829-G4	N/A	ELO® 2" Straight Round Pin Adj. Leg	6	26.25 - 40.25	





Jr. Adjustable Legs

Model #	Smooth Silver SKU	Black SKU	Description	Weight	Overall Height"	
ELO -EJA	0400755-G4	0400755	ELO® 1.25" Square Jr. Adj. Leg	5	21.25 - 26.25	 
ELS -EJA	04066652-G4	04066652	ELO® 2" Straight Round Jr. Adj. Leg	6	21.25 - 34.25	 
ELP -EJA	04066785-G4	N/A	ELO® 2" Straight Round Pin Jr. Adj. Leg	6	20.25 - 30.25	



Fixed Legs









Model #	Smooth Silver SKU	Black SKU	Description	Weight	Overall Height"	
ELS -FX	04067792-G4	N/A	ELO® 2" Round Fixed Leg w/Grand Hank Glide	4	29.36	
ELS -FX-CA	04067839-G4	N/A	ELO® 2" Round Fixed Leg w/Dual Wheel Soft Tread Locking Caster	4	29.36	



Mini Jr. Adjustable Legs

Model #	Smooth Silver SKU	Black SKU	Description	Weight	Overall Height"	
ELS -MJA	04067425-G4	N/A	ELO® 2" Round Jr. Adj. Mini Leg w/Grand Hank Glide	4	12 - 19	

Part Identifier Key

Part #	Description	Qty.	
040164	2.5" Grand Hank Nylon Glide, 3/8-16x1"	1 per leg	
04067920	1.5" Soft Touch Glide	1 per leg	
NSL-33056S	1.25" Steel Glide	1 per leg	
04067540	Dual Wheel Soft Tread Locking Caster	1 per leg	
04009308-X1 (black) 04009308-G4 (smooth silver)	Backpack Hook (Needs (2) 1/4"-20x15mm Joint Connector Bolts)	1	
04009023	1/4"-20x15mm Joint Connector Bolts (Used to fasten leg to top & for Backpack Hook)	<ul style="list-style-type: none"> • 6 per leg* • 2 per backpack hook 	
04009377 (42") 04066738 (50") 0407127 (60") 0407118 (72")	Stretcher Bar	0 to 2 depending on model	
0404248	#8x3/4" screws (Used to fasten stretcher bar to top)	10	

*A typical desk/ table has 4 legs - see below for a list of desks and tables that require a support bar/s or 3, 5 or 6 legs.

Desks	# of Legs
Connect 4	3
Diamond	3
Mini Diamond	3
Mini Nimubs	3
Pyramid	3

Tables	# of Legs	# of Support Bars
Rectangle up to 72" L	4	1 (only on 72"L)
Rectangle 84" & 96" L	6	-
Kidney (221)	4	1

Shaped Tables	# of Legs
Benton	5
Delta	5
Double Delta	6
Flower	6
Horseshoe (240)	5
Horseshoe (244)	5
Horseshoe (241)	5
Manta	3
Nimbus	3
Tri-	6

Court Tables	# of Legs	# of Support Bars
36"D X (60"L & 72"L)	4	1
36"D X 96"L	5	1
42"D x (60"L - 96"L)	5	1
48"D X (60"L - 84"L)	5	1
48"D X 96"L	6	1
60" D x (60"L - 66"L)	5	2