

Assembly Instructions

Before you begin, please make sure all parts and proper quantities are included. (See Part Identifier Key) Any parts damaged during shipment must be reported within 24 hours of receipt. To report information regarding damages or if you have any questions, please call 800.242.2303.

Step 1:

- Place the LOBO top face down on a protected flat surface.

Step 2:

- Place LOBO frame tabs down on top of the LOBO top and align with pre-drilled pilot holes.
- If assembling a **Stainless Steel top**, see Stainless Steel LOBO Table Assembly Instructions.
- If assembling an **Epoxy top**, see Epoxy LOBO Table Assembly Instructions.
- If assembling a **2 piece Hardwood top**, see Hardwood LOBO Table Assembly Instructions.

Step 3:

- Starting at one corner, place the $\frac{5}{16}$ " bolt that is welded to leg through corner support brace of frame. Repeat for remaining legs.

Step 4:

- Using a # S2 square bit, secure the leg plate to the top with #10 x $\frac{3}{4}$ " square pan screws. Repeat for each leg plate.

Step 5:

- Place the $\frac{5}{16}$ " lock washer and $\frac{5}{16}$ " hex nut onto the leg bolt and tighten with $\frac{1}{2}$ " wrench. Repeat on remaining legs.
- Adjust the leg to desired height.

Step 6:

- Using a # S2 square bit, secure frame to table top with #10 x $\frac{3}{4}$ " square pan screws. One screw per tab.

Step 7:

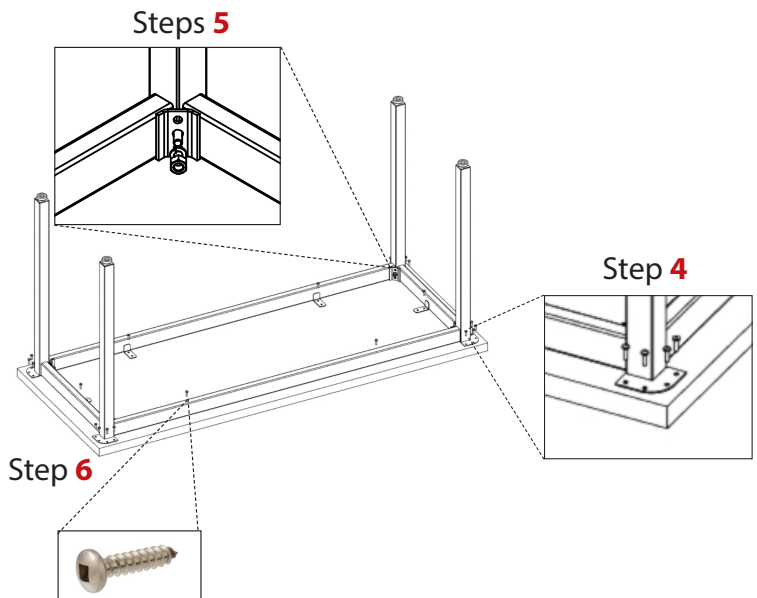
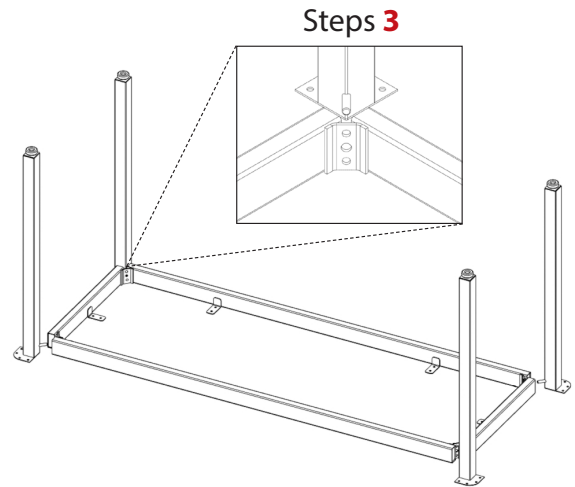

- With someone's help, turn table upright.



Tools Required

- $\frac{1}{2}$ " wrench
- Screw gun
- # S2 square bit

Part Identifier Key

Part #	Description	Qty.	
0408231	#10 x 3/4" Square pan screws <i>(Used to attach leg plates and frame to top)</i>	26 (Included in Hardware Pack located in leg box. May need less depending on size and work service)	
Hardware Pack 040379	5/16" Lock washers 5/16" Hex nuts <i>(Used to attach legs to frame)</i>	4 4	

3" Heavy Duty Caster Hardware Pack (04066968) Used only with 2" adj. legs (-ALR & -ABP)

Part #	Description	Qty.	
04067460	1/4" Star washers	4 per set	
04067064	M6 1x18 screws <i>(Used in leg insert to prevent bending of the leg insert)</i>	4 per set (Included in Hardware Pack located in leg box as standard. Discard if casters are not installed.)	

3" Heavy Duty Caster Hardware Pack (0402020) Used only with 1.5" adj. legs (-ADJ)

Part #	Description	Qty.	
04067460	1/4" Star washers	4 per set	
0401259	M6 1x14 screws <i>(Used in leg insert to prevent bending of the leg insert)</i>	4 per set (Included in Hardware Pack located in leg box as standard. Discard if casters are not installed.)	



LOBO Legs

Adjustable Legs

Model #	Sku #	Smooth Silver Sku#	Black Sku#	Description	Weight	Height"
LOB -ADJ	0409195-G4	0409195		LOBO 1.5" (40mm) Square Adj. Leg	18	22 - 36.6
LOB -ALR	0409193-G4	0409193		LOBO 2" (50mm) Round Adj. Leg	20	22.25 - 36.25
LOB -ABP	N/A	0409196		LOBO 2" (50mm) Big Paw Sq. Adj. Leg	20	22.25 - 36.25

Fixed Legs

Model #	Sku #	Smooth Silver Sku#	Black Sku#	Description	Weight	Height"
LOB -FX	0409194-G4	0409194		LOBO 1.5" (40mm) Square Fixed Leg	16	28.5

Assembly Instructions

Before you begin, please make sure all parts and proper quantities are included. (See Part Identifier Key) Any parts damaged during shipment must be reported within 24 hours of receipt. To report information regarding damages or if you have any questions, please call 800.242.2303.

Step 1:

- Remove Nylon glide from leg by rotating counterclockwise until glide is free.

Step 2:

- Place stem of optional footing into the hole on the leg. Rotate clockwise until fully inserted into leg.
- Casters are **NOT** to be used as a leveling device.

Step 3:

- Tighten with a 14mm open-ended wrench. (only with the Dual wheel soft tread locking caster.)

Step 4:

- Repeat for each caster or glide.

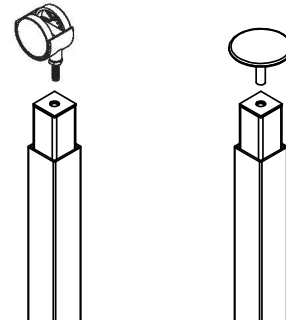





Installing casters on tables with epoxy resin tops will void the Epoxy warranty.

Tools Required

- 14mm open-ended wrench

Part Identifier Key

Part #	Description	Qty.	
040164	1 3/8" Dia. Grand Hank glide, 3/8"-16 x 1"	1 per leg	
04067920	1.5" Soft Touch glide	1 per leg	
33056S	1.25" Steel glide	1 per leg	
04067540	Dual wheel soft tread locking casters (N/A on epoxy resin tops)	1 per leg	



LOBO Legs

Adjustable Legs

Model #	Smooth Silver	Black	Description	Weight	Height"
	Sku #	Sku#			
LOB -ADJ	0409195-G4	0409195	LOBO 1.5" (40mm) Square Adj. Leg	18	22 - 36.6
LOB -ALR	0409193-G4	0409193	LOBO 2" (50mm) Round Adj. Leg	20	22.25 - 36.25
LOB -ABP	N/A	0409196	LOBO 2" (50mm) Big Paw Sq. Adj. Leg	20	22.25 - 36.25

Fixed Legs

Model #	Smooth Silver	Black	Description	Weight	Height"
	Sku #	Sku#			
LOB -FX	0409194-G4	0409194	LOBO 1.5" (40mm) Square Fixed Leg	16	28.5

Assembly Instructions

Before you begin, please make sure all parts and proper quantities are included. (See Part Identifier Key) Any parts damaged during shipment must be reported within 24 hours of receipt. To report information regarding damages or if you have any questions, please call 800.242.2303.

Step 1:

- Before placing caster in the bottom of the leg, lock the caster by pushing down on the brake lever.

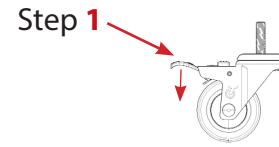

Step 2:

- Twist the stem of the caster into the hole on the bottom of the leg. Applying thread locking adhesive can help prevent unexpected loosening of the caster.

Step 3:

- Use 3/4" wrench to tighten 3/4" nut on stem of caster.

Step 4:

- If using adj. legs, insert star washer and M6 screw in hole closest to the caster and tighten with 4mm hex wrench. **DO NOT OVER TIGHTEN.**
- If using a **FIXED leg**, you will **NOT** need to use a star washer and M6 screw.

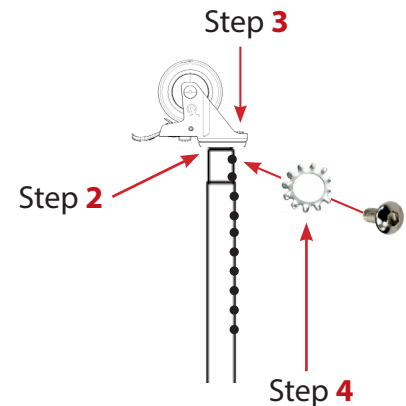

Step 5:

- Repeat for remaining casters.

Casters are **NOT** to be used as a leveling device.

Tools Required

- 3/4" Wrench
- 4mm Hex Wrench
- Thread Locking Adhesive (optional)

Installing casters on tables with epoxy resin tops will void the Epoxy warranty.

Part Identifier Key

Part #	Description	Qty.	
0400993	3" heavy duty locking casters	1 per leg	

3" Heavy Duty Caster Hardware Pack (04066968) Used only with 2" adj. legs (-ALR & -ABP)

Part #	Description	Qty.	
04067460	1/4" Star washers	4 per set	
04067064	M6 1x18 screws	4 per set	
<i>(Used in leg insert to prevent bending of the leg insert)</i>		<i>(Included in Hardware Pack located in leg box)</i>	

3" Heavy Duty Caster Hardware Pack (0402020) Used only with 1.5" adj. legs (-ADJ)

04067460	1/4" Star washers	4 per set	
0401259	M6 1x14 screws	4 per set	
<i>(Used in leg insert to prevent bending of the leg insert)</i>		<i>(Included in Hardware Pack located in leg box)</i>	