

## Assembly Instructions

Before you begin, please make sure all parts and proper quantities are included. (See Part Identifier Key on next page) Any parts damaged during shipment must be reported within 24 hours of receipt. To report information regarding damages or if you have any questions, please call 800.242.2303.

### Step 1:

- Place the Flip table top face down on a protected flat surface.

### Step 2:

- Remove Flip Top mechanism from box, place it on the Flip table top and making sure you align with pre-drilled pilot holes.
- Using a 4mm Allen wrench or 4mm Hex bit, secure mechanism (base plate) to table top with 10-24 x 1" joint connector bolts. Repeat for the 2nd mechanism (base plate).

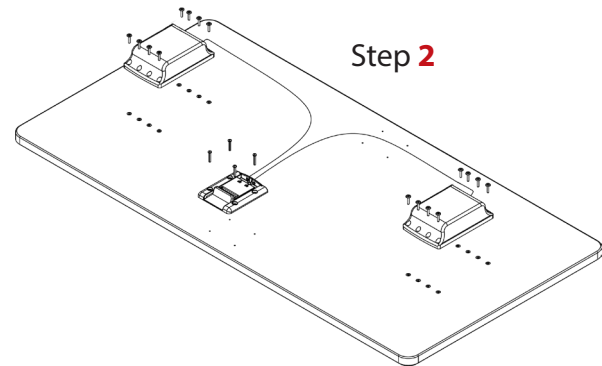

### Step 3:

- Place leg on mechanism (base plate). Using  $\frac{5}{32}$ " Ball End Allen wrench extension and battery operated hand drill to secure flat head screws (in assembly kit) into place. **DO NOT FULLY TIGHTEN**. See image to right, screws are circled in red.
- Use a normal "L" shaped Allen Wrench to firmly tighten 4 screws. **Do NOT use "T" shaped Allen wrench** since they twist and do not tighten screws properly.
- Repeat for other bases.

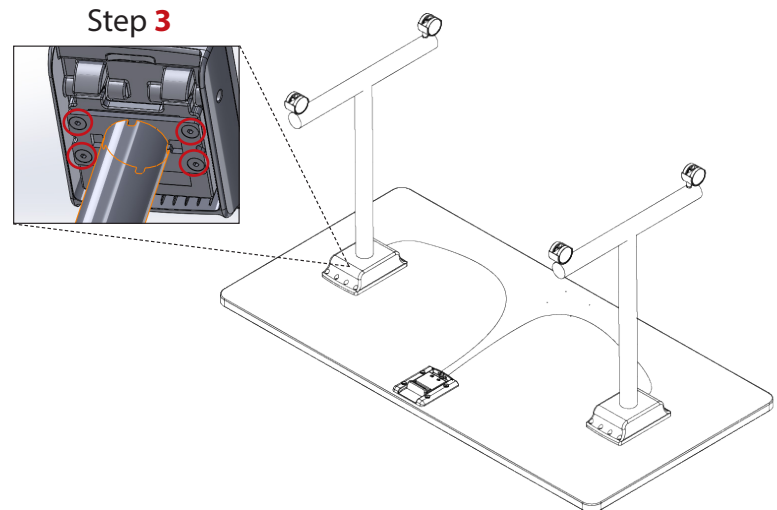

### Step 4:

- Using #2 square bit, secure handle release to table top using #10 x  $1\frac{1}{4}$ " square pan head screws.

### Step 5:

- Attach cord to the top with cable clips using Phillips head screws. See image to right for location of clips.
- The cord should be fluid without any kinks

### Step 6:



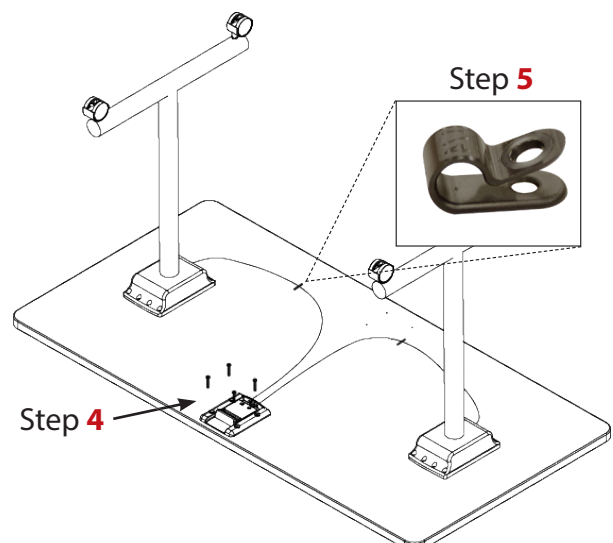

- With someone's help, turn table upright.



### Tools Required

- $\frac{5}{32}$ " Ball End Allen wrench extension
- Normal "L" shaped  $\frac{5}{32}$ " Allen wrench
- Screw gun
- $\frac{5}{32}$ " Hex Bit
- 4mm Allen wrench OR
- 4mm Hex bit
- Phillips head screwdriver
- #2 square bit

## Part Identifier Key

Part #	Description	Qty.	
0401158	10-24 x 1" joint connecor bolts <i>(Used to attach mechanism (bases plate) to top)</i>	16 (for 2 bases) 8 (for 1 base)	
	Flat head screws <i>(Used to attach leg on mechanism (base plate)</i>	8 (for 2 bases) 4 (for 2 bases) (Included in hardware pack located in leg box)	
Hardware Pack 0404239	#10 x 1 1/4" square pan head screws <i>(Used to attach handle release to top)</i>	4	
	Cable clips <i>(Used to hold down cable to top)</i>	4 (min. of 2 at installation) (Included in hardware pack located in leg box)	
	Phillips head screws <i>(Used to attach cable clips to top)</i>	4 (Included in hardware pack located in leg box)	

### Tubular T-Bases

Base #	Part #:	Table D"*
7722	04009399	24" & 30"
7726	04009880	36"



### Arch T-Bases

Base #	Part #:	Table D"*
7764	040197	24" & 30"
7768	04067272	36"



### DuraCast T-Bases

Base #	Part #:	Table D"*
5054	04009811	24"
5056	04067307	30" & 36"



\*Depth is for each set of legs.