

Lotz Armor Edge™ Tops:

Lotz Armor Edge™ top is constructed of 1.125" thick MDF (medium density fiberboard) core. MDF is a superior material for screw holding abilities exceeding 250 lbs., breaking strength and load tests. The back material is phenolic which **prevents moisture penetration** to core material and provides an anti gum surface. High pressure laminate is bonded to the **MDF core**. The .25" beveled radius edge is finished using our exclusive Lotz Armor Edge™, a polyurea, which is extremely strong and durable. **This edge will not separate from the MDF core material and makes the edge water tight.** Lotz Armor Edge™ comes black standard. Colors available.



3mm Tops:

The core material is 1.125" thick particle board with a phenolic backer sheet and high pressure laminate on top. 3mm PVC edge banding is applied to all sides, radius corners.



Optional top surface choices include **whiteboard laminate** and most Wilsonart matte (-60) finish laminates with possible up charges. Other vendors available upon request.

Shipping Class: 70
NMFC#: 83620-2

Standard Options:



Adjustable legs adjust in 1" increments with tamper resistant screws

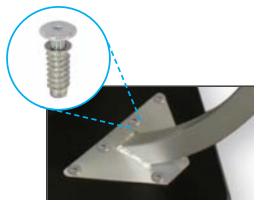

Legs positioned at widest point of desk for stability and attached via threaded metal inserts and screws



Pin adjustable legs adjust in 1" increments



1.375" Nylon Glide

Legs:

Legs are positioned at the widest point of the desk to improve stability and to provide more knee clearance. The adj. legs are constructed from your choices of the 1.25" Square, 2" Curved Round, 2" Straight Round or the 2" Straight Round Pin. All choices are 14-gauge tubular steel with a powder-coated smooth silver (-G4, standard) or textured black finish (-09). The legs are fully welded to a triangular 12-gauge mounting plate and are secured to the top with six metal-to-metal threaded inserts and .25"-20x15mm joint connector bolts (included). Threaded, case-hardened, self-leveling 1" adjustable nylon glides finish the leg.

1.25" Square Adj. Leg (ELO)

Leg Height Identifier	Leg Height	Desk Height
-ADJ	24.75"-29.75"	26"-31"
-EJA (Jr. leg)	20"-25"	21.25"-26.25"
-ADJSU (StandUp leg)	32.25"-42.25"	33.5"-43.5"



2" Curved Round Adj. Leg (ELR)

Leg Height Identifier	Leg Height	Desk Height
-ADJ	25"-30"	26.25"-31.25"
-EJA (Jr. leg)	21"-26"	22.25"-27.25"



2" Straight Round Adj. Leg (ELS)

Leg Height Identifier	Leg Height	Desk Height
-ADJ	27"-40"	28.25"-41.25"
-EJA (Jr. leg)	20"-33"	21.25-34.25"



2" Straight Round Pin Adj. Leg (ELP)

Leg Height Identifier	Leg Height	Desk Height
-ADJ	25"-39"	26.25"-40.25"
-EJA (Jr. leg)	19"-29"	20.25-30.25"



Frame Color Options:

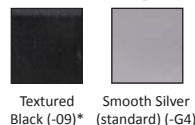

*Textured Black not available in the Pin Adj. Leg.

V120817 Specs subject to change.



Patent #
D780,487

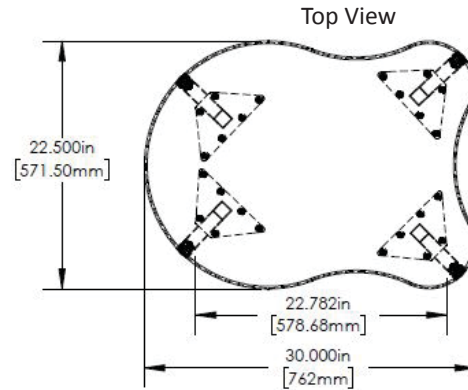

<i>AE Top</i>	<i>3mm Top</i>	<i>Description</i>	<i>Top DxDL</i>	<i>Desk H</i>
ELO7600-ADJ	ELO6600-ADJ	4 Square Adj. Legs	22.5" x 30"	26"-31"
ELO7600-EJA	ELO6600-EJA	4 Square Jr. Adj. Legs	22.5" x 30"	21.25"-26.25"
ELO7600-ADJSU	ELO6600-ADJSU	Stand Up, 4 Adj. Legs	22.5" x 30"	33.5"-43.5"
ELR7600-ADJ	ELR6600-ADJ	4 Curved Round Adj. Legs	22.5" x 30"	26.25"-31.25"
ELR7600-EJA	ELR6600-EJA	4 Jr. Curved Round Adj. Legs	22.5" x 30"	22.25"-27.25"
N/A	N/A	Sit To Stand, 4 Straight Round Adj. Legs	N/A	N/A
N/A	N/A	Sit To Stand, 4 Jr. Straight Round Adj. Legs	N/A	N/A
N/A	N/A	Sit To Stand, 4 Straight Round Pin Adj. Legs	N/A	N/A
N/A	N/A	Sit To Stand, 4 Jr. Straight Round Pin Adj. Legs	N/A	N/A

Optional Features:



Steel book box (-LB)

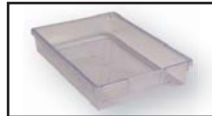

Clear View tote tray (can interchange with tote storage unit) (-TB)



Full Color tote tray (can interchange with tote storage unit) (See catalog for color selection)



Wire Basket (-LW)



Backpack hook



Dual wheel locking casters (-CA)



2.5" Grand Hank Glide (-HG)



22.5" x 30"

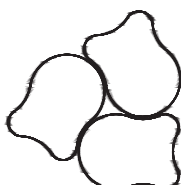

Dia= 60"

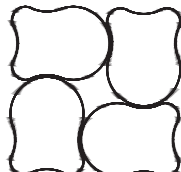

Dia= 63"

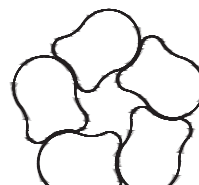

Dia= 73"

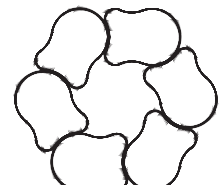

Dia= 81"